

Article number: 20288B20B25T2BL

Description: E+G Swivel clamp - GN 288-B20-B25-T-2-BL

Measures

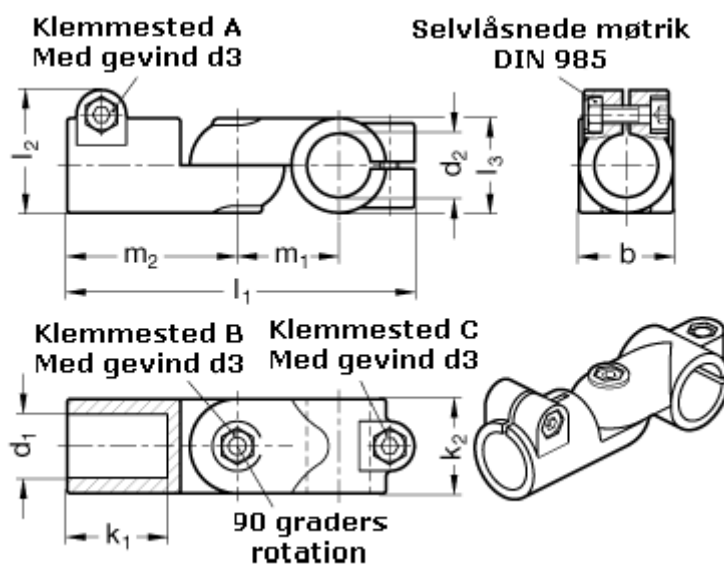

$b = 40$	$m_1 = 43$
$d_1 = B20$	$m_2 = 72$
$d_2 = B25$	
$d_3 = M 8$	
$k_1 = 42.5$	
$k_2 = 40$	
$l_1 = 147$	
$l_2 = 52.0$	